



RockRazor™ Foundation Drilling & Trenching Platform



Introducing

RockRazor™

The new *quick-change* indexable cutting system for earthworks.



The RockRazor™ system's quick change ability reduces machine downtime by allowing flexibility to change from one tool style to another depending on the application. This flexibility allows you to maximize cutting capabilities of your equipment.

Quick change

From a non-rotating, flat-spade tool to a rotating conical based on your application.

The benefits for you are:

- ▶ Flexibility of tool-style changes depending on conditions.
- ▶ Quick-change system results in less downtime.

Quick change

The indexable system enables use of a four-position flat spade tool for soft materials, and facilitates quick changes to carbide conicals for harder materials.

The benefits for you are:

- ▶ Significant cost savings by reducing downtime during tool changes.



FLEXIBLE
COMPREHENSIVE
PRODUCTIVE
EFFICIENT
POWERFUL

Application Guide

	Cutting Conditions	Soft Cutting	Medium Cutting	Hard Cutting	Abrasive Cutting	Highly Abrasive & Hard Cutting	Laminated Chunk Rock
	Types of Rock	Soapstone Gypsum Slate Shale	Soft Limestone Caliches	Dolomite Limestone Concrete River Rock	Sandstone Basalt Coral Asphalt	Flint Silica Sandstone Granite	Limestone River Rock Sandstone Flagstone
	Small Track & Rock Saw Trenchers	T1 or T5 T7 or T16 T17 or T18	T5 or T7 T16 or T17 T18 or T20	T11 T19 T20	T8 "X" T19 "X" T20 "X"	T11 "X" T19 "X" T20 "X"	T11 T19 T20
	Large Track & Rock Saw Trenchers	TS19C TS20C TS39C	TS19C or TS20C TS31C or TS32C TS35C or TS39C	TS5C or TS7C TS30C or TS32C TS40C or TS41C	TS14C "X" or TS33C "X" TS30C "X" or TS32C "X" TS40C "X" or TS41C "X"	TS30C "X" TS31C "X" TS32C "X"	TS30C TS31C TS32C
	Bucket Wheel Trenchers	FC01 Indexable Flat Spade Bit	FC01 Indexable Flat Spade Bit	TS30C TS31C TS32C	TS35C "X" TS36C "X" TS37C "X"	TS30C "X" TS31C "X" TS32C "X"	TS30C TS31C TS32C
	Drilling Rig	DS04 DS04-59 DS01 DS12WC DS10WC	DS04 DS04-59 DS01 DS12WC DS10WC	DS05 DS07WC DS09WC DS11WC DS12WC	DS07WC "X" DS08WC "X" DS11WC "X" DS12WC "X"	DS07 WC "X" DS11WC "X" DS12WC "X"	DS07WC "X" DS09WC "X" DS10WC "X" DS11WC "X" DS12WC "X"

Blocks

	TH3-G	order number 5031746	catalog number TH3-G-INDEX BLOCK
	TH3S-G	order number 5031772	catalog number TH3S-G-INDEX BLOCK
	TH3-100	order number 2956994	catalog number TH3-100 BLOCK

Retainers

	TR1-D Retainer (T & TX Series)	order number 4065385	catalog number TR1-D
	C31R Retainer (T & TX Series)	order number 1012065	catalog number C31R RETAINER
	TR3 Retainer (FC01, TSC & TSCX Series)	order number 4073124	catalog number TR3 RETAINER
	C15R Retainer (FC01, TSC & TSCX Series)	order number 1803295	catalog number C15R RETAINER
	KR-112 BE Retainer (TS & TSX Series)	order number 4055765	catalog number KR-112 BE RETAINER
	DSL-R Retainer (DS & DSWC Series)	order number 4131992	catalog number DSL-R 1070 RETAINER CLIP
	DSL-R-D Retainer (DS & DSWC Series)	order number 5032127	catalog number DSL-R-D RETAINER CLIP
	TS-CX Series		
	TS-X Series		

Non-Rotating Flat Spade Bit

	FC01-Index	order number 5031774	catalog number FC01-INDEX FLAT SPADE BIT
--	-------------------	-------------------------	---

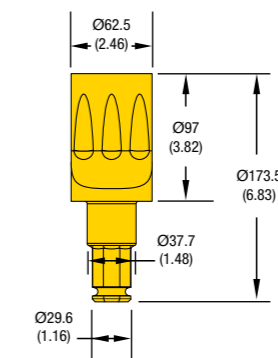

Gold

Trenching Tools 38 mm (1.5") / 30 mm (1.18")

3.5 Gage



TSX Series/TSCX Series

Dimensions below are shown in millimeters and (inches).

■ **TS8 X**
■ **TS8C X**

order number	catalog number
4082921	TS8 X
4082889	TS8C X

■ **TS20 X**
■ **TS20C X**

order number	catalog number
4066790	TS20 X
4066813	TS20C X

■ **TS35 X**
■ **TS35C X**

order number	catalog number
4066823	TS35 X
4046251	TS35C X

■ **TS36 X**
■ **TS36C X**

order number	catalog number
4066824	TS36 X
4066825	TS36C X

■ **TS37 X**
■ **TS37C X**

order number	catalog number
4066829	TS37 X
4066875	TS37C X

See Application Guide on page 2.

Gold

Trenching Tools 38 mm (1.5") / 30 mm (1.18")

3.0 Gage

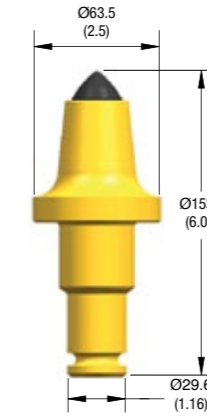

TSX Series/TSCX Series

Dimensions below are shown in millimeters and (inches).

■ **TS7 X**
■ **TS7C X**

order number	catalog number
4082920	TS7 X
4082888	TS7C X

■ **TS19 X**
■ **TS19C X**

order number	catalog number
4066767	TS19 X
4066765	TS19C X

■ **TS31 X**
■ **TS31C X**

order number	catalog number
4066873	TS31 X
4066872	TS31C X

■ **TS30 X**
■ **TS30C X**

order number	catalog number
4050637	TS30 X
4050638	TS30C X

■ **TS32 X**
■ **TS32C X**

order number	catalog number
4066816	TS32 X
4066821	TS32C X

■ **TS39 X**
■ **TS39C X**

order number	catalog number
4066876	TS39 X
4066877	TS39C X

See Application Guide on page 2.

Gold

TSX Series/TSCX Series

Trenching Tools 38 mm (1.5") / 30 mm (1.18")

Dimensions below are shown in millimeters and (inches).

2.5 Gage

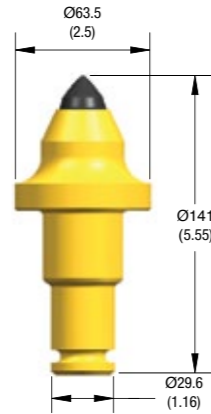

- TS5 X
- TS5C X

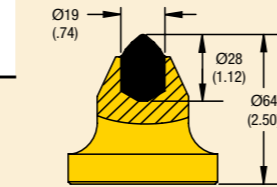

order number	catalog number
4082919	TS5 X
4009193	TS5C X

- TS14 X
- TS14C X

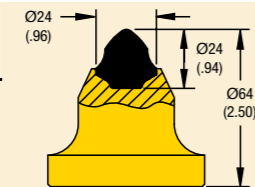

order number	catalog number
4082922	TS14 X
4082890	TS14C X

- TS34 X
- TS34C X

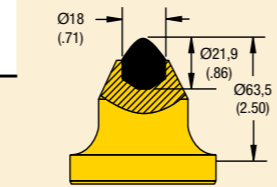

order number	catalog number
4082923	TS34 X
4082891	TS34C X

- TS33 X
- TS33C X

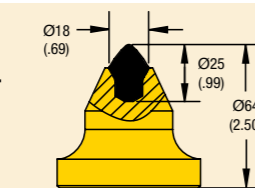

order number	catalog number
4066822	TS33 X
4009196	TS33C X

- TS40 X
- TS40C X

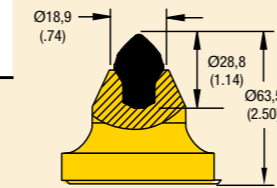

order number	catalog number
4066832	TS40 X
4009198	TS40C X

- TS41 X
- TS41C X

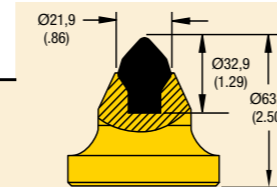

order number	catalog number
4066864	TS41 X
4066869	TS41C X

See Application Guide on page 2.

Gold

TX Series

Trenching Tools 25 mm (1")

Dimensions below are shown in millimeters and (inches).

3.0 Gage

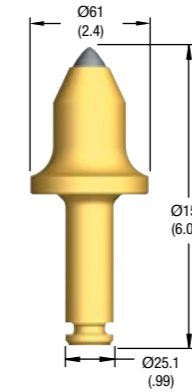

- T7 X

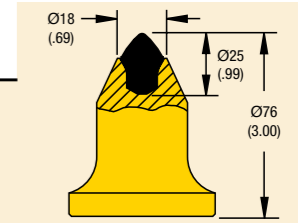

order number	catalog number
4065448	T7 X

- T16 X

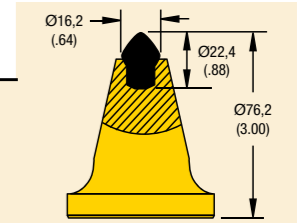

order number	catalog number
4065494	T16 X

- T18 X

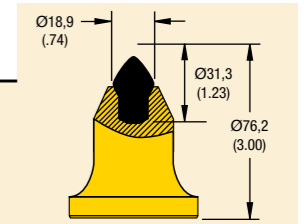

order number	catalog number
4065497	T18 X

See Application Guide on page 2.

Gold

TX Series

Trenching Tools 25 mm (1")

Dimensions below are shown in millimeters and (inches).

2.5 Gage

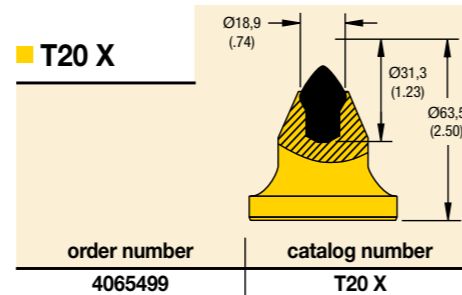
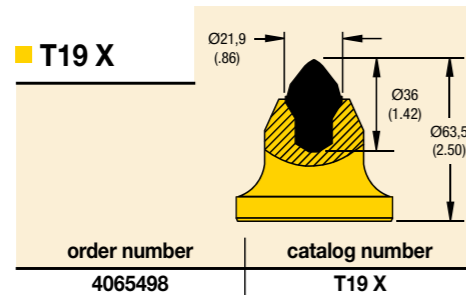
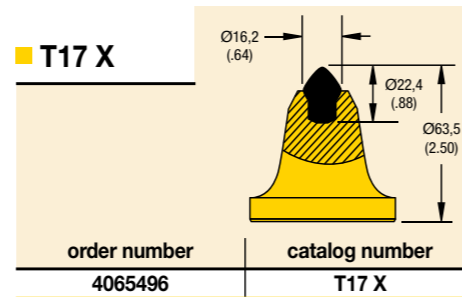
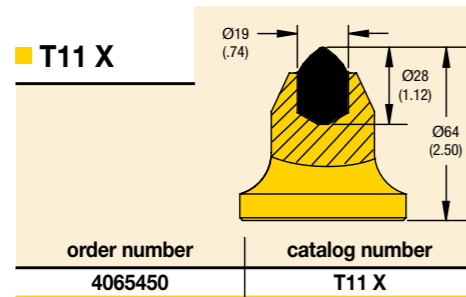
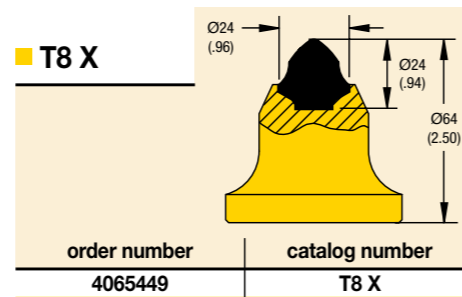
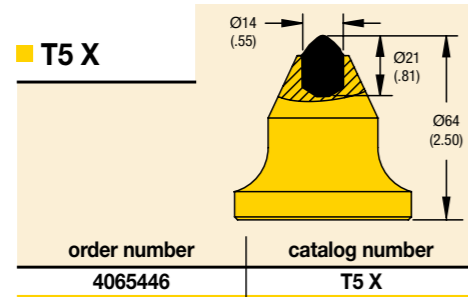
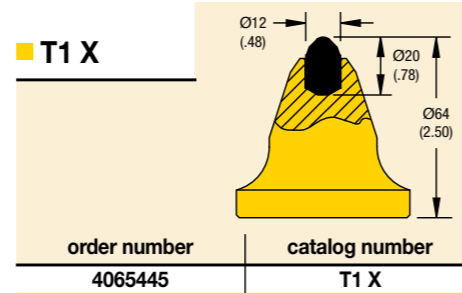
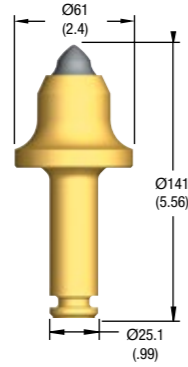

Gold

DSWCX Series

Foundation Drilling Tools

Dimensions below are shown in millimeters and (inches).

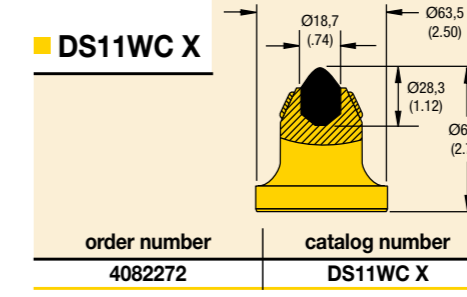
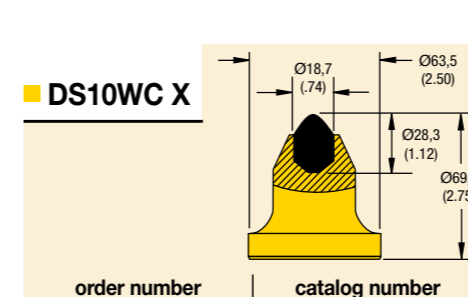
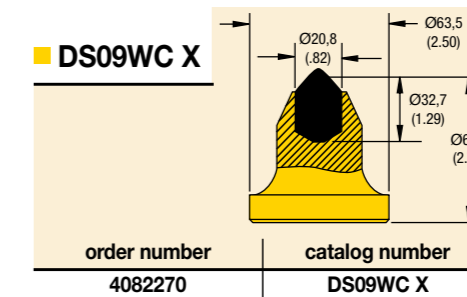
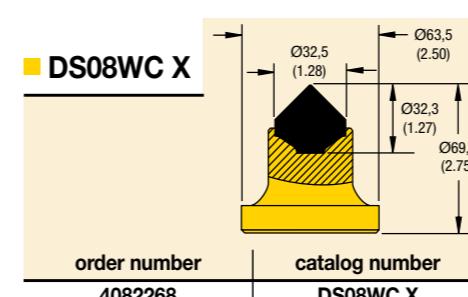
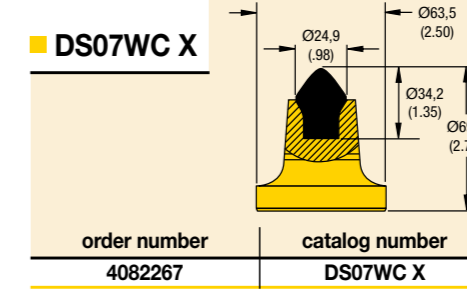
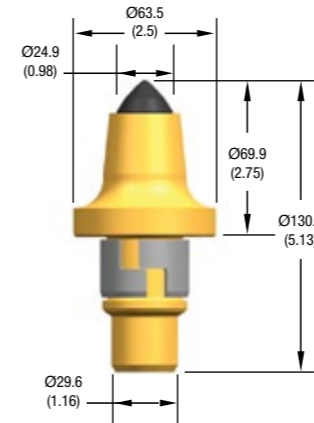

See Application Guide on page 2

For customer service or to place an order contact:

Argentina
Phone: 54.011.4719.0700
Fax: 54.011.4719.6116

Australia/New Zealand
Phone: 61.7.3801.5844
Fax: 61.7.3801.5826
sydney.service@kennametal.com

Brazil/Latin America
Phone: 55.19.3936.9200
Fax: 55.19.3936.9201

Chile
Phone: 56.2.2641177
Fax: 001.888.442.4964

China
Phone: 86.400.6501.388
Fax: 86.10.8561.5263

Germany/European Served Area
Phone: 49.6172.737.498
Fax: 49.6172.737.42.453
mcs-ag.service@kennametal.com

India
Phone: 91.80.2839.4321
Phone: 91.80.2219.8444
Fax: 91.80.2839.1300
bangalore.information@kennametal.com

Japan
Phone: 81.3.3820.2855
Fax: 81.3.3820.2800

Korea
Phone: 82.2.2109.6967
Fax: 82.2.2109.6981

Malaysia/Indonesia
Phone: 6.03.5569.9080
Fax: 6.03.5569.0080

Poland/Slovakia/Baltics
Phone: 48.32.42.15.888
Phone: 48.32.42.15.405
Fax: 48.32.47.89.112

South Africa/Sub Saharan Area
Phone: 27.11397.3540
Fax: 27.11397.3222

**Thailand/Singapore/
Vietnam/Philippines**
Phone: 66.2642.3455
Phone: 66.2246.8025.32
Fax: 66.2641.2736.8

United States/Canada/Mexico
Phone: 800.458.3608
Fax: 800.521.3319

World and Corporate Headquarters

Kennametal Inc.
1600 Technology Way
Latrobe, PA 15650 USA
Phone: 800.446.7738 (United States and Canada)
info@kennametal.com

European Headquarters

Kennametal Europe GmbH
Rheingoldstrasse 50
CH 8212 Neuhausen am Rheinfall
Switzerland
Phone: 41.52.6750.100
neuhausen.info@kennametal.com

Asia-Pacific Headquarters

Kennametal Pte. Ltd.
No.11 Gul Link Jurong
Singapore 629381
Phone: 65.6.2659222
sales@kennametal.com.sg

India Headquarters

Kennametal India Limited
8/9th Mile, Tumkur Road
Bangalore - 560.073
Phone: 91.80.2839.4321
bangalore.information@kennametal.com



www.kennametal.com